

KELLENBERGER K10

THE UNIVERSAL PLATFORM
FOR CYLINDRICAL GRINDING



KELLENBERGER K10

THE UNIVERSAL PLATFORM FOR CYLINDRICAL GRINDING

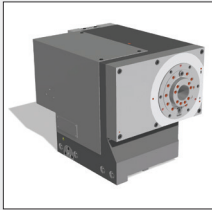

UNIVERSAL WORKHEAD

- Applications Live and Dead centers spindle
- Rotating speed 1-1000 rpm
- Undress accuracy $\leq 0.4 \mu\text{m}$ (optional $\leq 0.2 \mu\text{m}$) Fine angle adjustment with correction range $\pm 1.5^\circ$
- Positioned spindle stop for thread grinding

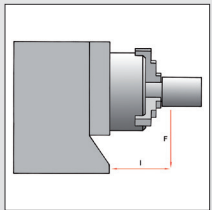

LOAD WITH CHUCKED WORK

- 100 Nm

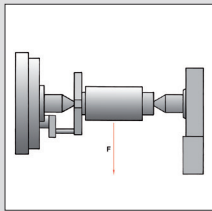

LOAD BETWEEN CENTERS

- 100 kg



TAILSTOCK 100

- Workpiece weight up to 100 kg
- Morse taper 4
- Retraction of sleeve 49 mm
- Micro-adjustment $\pm 30 \mu\text{m} / \text{Ø}$
- Pneumatic lifting



Perfection at a glance

- High process reliability
- Wide range of parts
- Easy setup
- No external influences on the machining process
- High productivity and flexibility
- Fast startup
- Short delivery period
- High availability and trustworthiness
- Reduced maintenance costs
- Excellent price-performance ratio



Basis

- FEM-optimized cast bed for the highest quality and the longest durability
- Mechanical separation of machine and periphery for thermal stability and minimization of vibration influences

Table/Slide

- Linear guide on X-axis tested 1,000 times for low maintenance and high precision
- Low-wear slideway on Z-axis
- 50 Nm glass scales on X- and Z-axes
- High dynamic through speed up to 20 m/min in Z- and 10 m/min in X-axis

CYLINDRICAL GRINDING MACHINE



Controller CNC Fanuc Oi Plus

- 19" LCD color monitor with touch-screen function
- BLUE Solution teach-programming with OBJECT Guide for guided and simple program creation on workpiece
- IPC operating system Windows 10 IoT
- Hand-held panel with axis and speed selector switches

ERGONOMICS

- Visually and ergonomically advanced design
- Good overview of the grinding process
- Centrally arranged and easily accessible Interfaces for table superstructures
- Swiveling control panel for optimized operating comfort
- Intelligent accessibility for cost-effective maintenance and service

UR WHEELHEAD

- A grinding head for external cylindrical, internal cylindrical and face grinding
- Internal grinding with variable circumferential speed
- Automatic 1° indexing of a swivel device
- Thermal stability due to optimized spindle bearings and water-cooled motor
- Drive power of 7.5 kW
- Max. wheel diameter of $\varnothing 500 \times 80 \times 203\text{mm}$

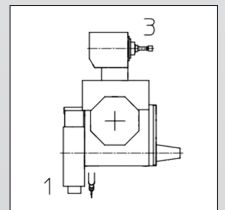
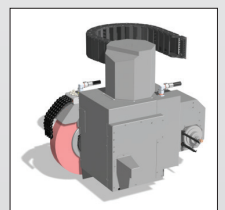
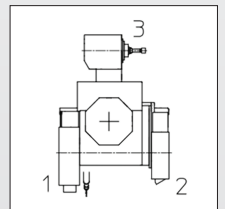
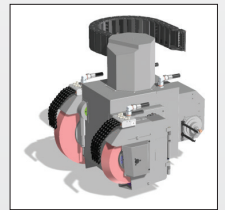

Swivel device

- Automatic indexing 1°

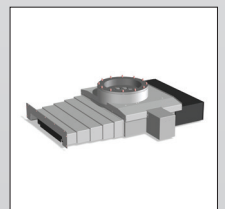

OPTIONAL CONFIGURATIONS

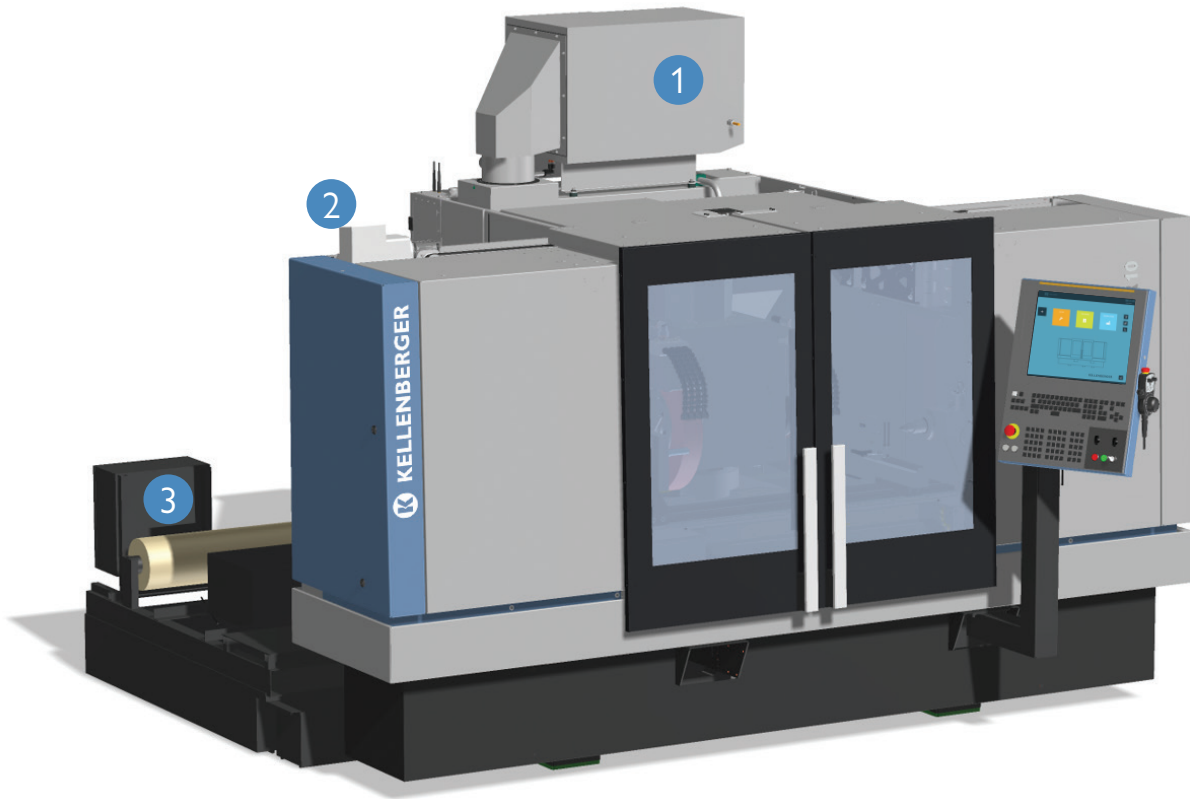

- ① Mist-extraction unit
- ② Automatic sliding doors
- ③ Coolant-based filter system
- ④ External grinding wheel
- ⑤ Tailstock
- ⑥ Active flagging device
- ⑦ Gap control and balancing sensors
- ⑧ Integrated lifting system
- ⑨ Wide range of table superstructures
 - Dressing devices
 - Steady rest
 - In-process measurement
- ⑩ Workhead
- ⑪ Control panel

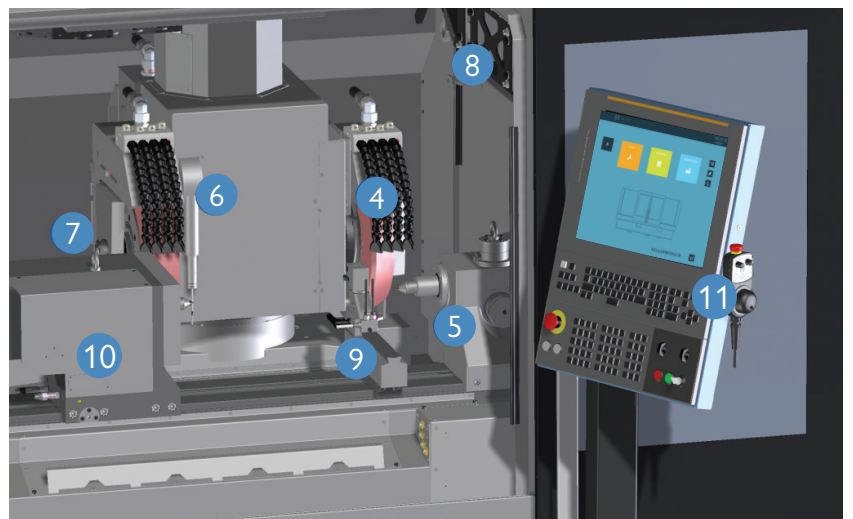

ACCESSORIES

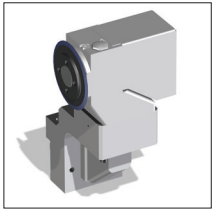

Dressing device

- Static diamonds
- Rotating

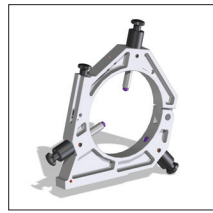

Steady Rest

- Support for long workpieces

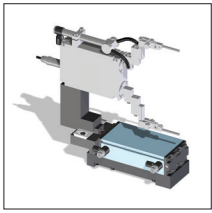

Measurement control

- In-process gage system

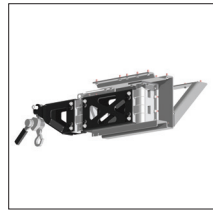

Integrated lifting system

- Ergonomic lifting system for table assemblies and grinding wheels

Transport

- Efficient commissioning due to different lifting options



Various Dressing options

Fixed dressing unit on table superstructures in the standard accessories with fixed and rotating dressing devices.

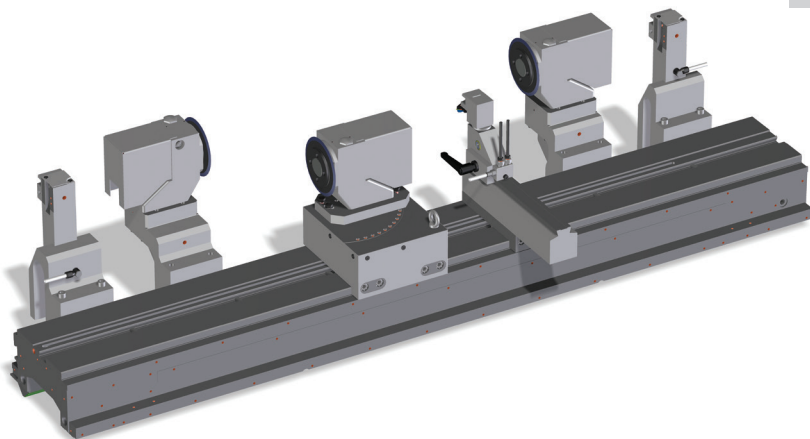

Automatic sliding doors

- Relief for the operator
- Faster workpiece changover times

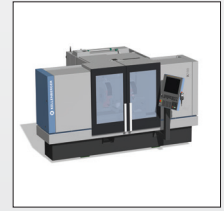

INTERNAL GRINDING ATTACHMENT

- Grease-lubricated HF internal grinding spindle
6'000 - 40'000 min-1
10'000 - 60'000 min-1
- Inexpensive and compact

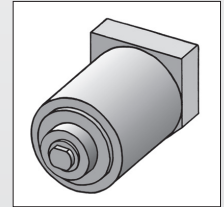

gtouch

- Optimized process time

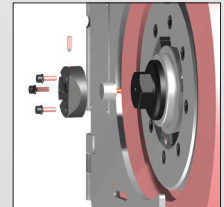

Semi-automatic balancing

- Faster setup
- Monitoring of the balance quality

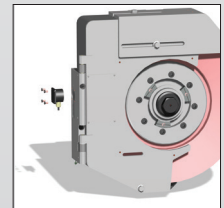

Active Flagging Device

- Active measurement in external machining
- Calibration of a workpiece position in Z-position
- Mounted on the grinding head

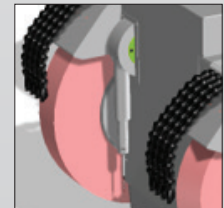

FANUC CONTROL Oi-F PLUS WITH KELLENBERGER HMI

The BLUE Solution user interface from Kellenberger has the central focus on simple and intuitive operation. All interactions are carried out by gestures on the 19" touch display. The latest generation of a reliable FANUC Oi-F Plus control runs in the background.

Blue Solution

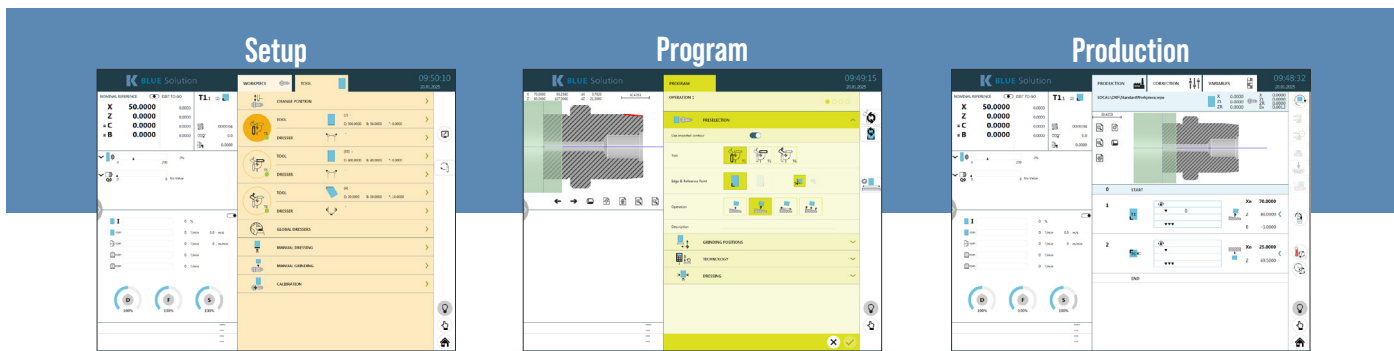

The user interface was developed explicitly for grinding by our specialists in cooperation with customers. BLUE Solution supports users regardless of their level of experience in all important steps from setup to production.

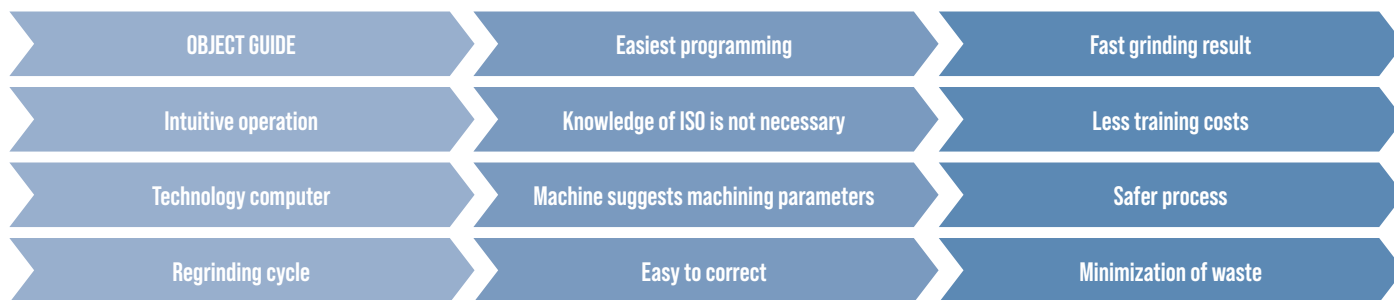

BLACK CAM SOLUTION

With the additional BLACK CAM Solution software, NC programs for grinding and dressing of profiles and threads can be generated, simulated and analyzed.

The CAD-CAM software supports the structured creation, processing and management of all documents belonging to a workpiece.

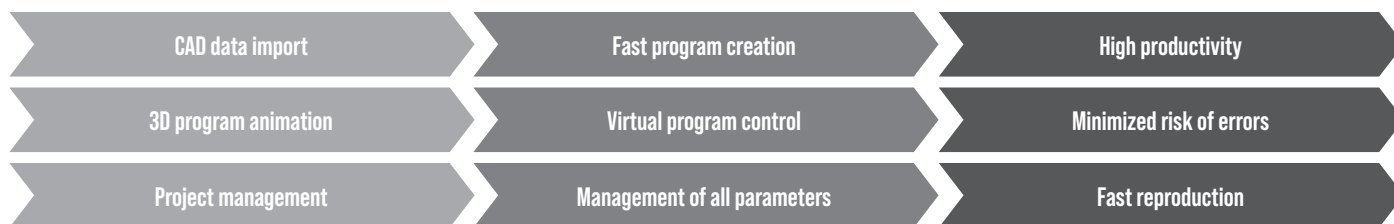
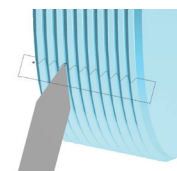

INDUSTRY 4.0

The Security Interface ensures communication according to the highest IT security standard between the machine and the production network.

The optional Remote Diagnostic module simplifies efficient diagnosis in case of service and thus reduces downtimes.

The machine is prepared for Industry 4.0. With the ComGateway, which has a standard OPC-UA server, extensive information on process and machine status can be exchanged.



TECHNICAL DATA

Characteristics		
Distance between centers	mm	1.000
Center height	mm	200
Weight of workpiece between centers	kg	up to 100
Load on chucked work	Nm	up to 100
Mains voltage required	V	380 / 400 / 460
Power consumption depending on equipment	A	up to 40
Space required (length x width)	m	3.5 x 2.2
Total weight	kg	4500
Table/Slide Z-axis		
Travel	mm	1.150
Rapid traverse speed	m/min	up to 20
Resolution	mm	0.00001
Wheelslide X-axis		
Travel	mm	365
Rapid traverse speed	m/min	up to 10
Resolution	mm	0.00001
Swivel devices		
Swiveling range	degree	240
automatic indexing of resolution	degree	1
Wheelhead		
Water-cooled drive motor	KW	7.5
Performance peripheral speed	m/s	up to 50
Grinding wheel dimensions	mm	up to Ø500x80
Internal grinding device		
Bore for spindles up to	mm	150
Power, HF spindles	KW	up to 7.5
Rotation speed	rpm	up to 60.000
Workhead		
Rotation spindle speed	rpm	1 - 1,000
Interface		ISO 702-1, Size 5/MT5
Roundness accuracy in chucked work	µm	0.4 (optional 0.2)
Tailstock		
Internal taper		MT4
Retraction of sleeve	mm	49
Micro-adjustment	µm	± 30

All specifications and designs are subject to alterations without notice

SETUP PLAN

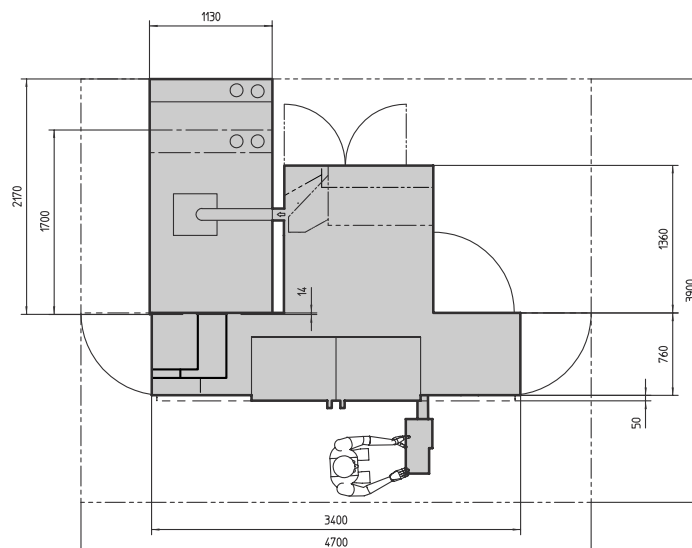



EUROPE & ASIA

Kellenberger Switzerland AG
Thannäckerstrasse 22
9403 Goldach
Tel. +41 71 242 91 11
info@kellenberger.net

AMERICA

Kellenberger Systems
1755 Britannia Drive, Unit A
Elgin, Illinois 60124
Tel. +800 8438801
info@kellenberger.com

CHINA

Kellenberger
1388 East Kang Qiao Road
Pudong, Shanghai 201319
Tel. +86 21 38108686
info@kellenberger.net

All prices and details are subject to change without notice. 1/2025

kellenberger.com

